



# ACE4606TB

## 30V Complementary Enhancement Mode Field Effect Transistor

### Description

The ACE4606TB uses advanced trench technology MOSFETs to provide excellent  $R_{DS(ON)}$  and low gate charge. The complementary MOSFETs may be used in inverter and other applications.

### Features

N-channel

- $V_{DS}=30V$
- $I_D=7A$
- $R_{DS(ON)} < 26m\Omega$  ( $V_{GS}=10V$ )
- $R_{DS(ON)} < 45m\Omega$  ( $V_{GS}=4.5V$ )

P-channel

- $V_{DS}=-30V$
- $I_D=-4A$
- $R_{DS(ON)} < 58m\Omega$  ( $V_{GS}=-10V$ )
- $R_{DS(ON)} < 80m\Omega$  ( $V_{GS}=-4.5V$ )

### Absolute Maximum Ratings

Parameter	Symbol	N-channel	P-channel	Unit	
Drain-Source Voltage	$V_{DSS}$	30	-30	V	
Gate-Source Voltage	$V_{GSS}$	$\pm 20$	$\pm 20$	V	
Drain Current (Continuous)*AC	$I_D$	$T_A=25^\circ C$	7	-4	A
		$T_A=70^\circ C$	6	-3	
Drain Current (Pulse) *B	$I_{DM}$	28	-16		
Power Dissipation	$P_D$	$T_A=25^\circ C$	2		W
		$T_A=70^\circ C$	0.8		
Operating Temperature/ Storage Temperature	$T_J, T_{STG}$	-55 to 150		$^\circ C$	

A: The value of  $R_{\theta JA}$  is measured with the device mounted on 1in<sup>2</sup> FR-4 board with 2oz. Copper, in a still air environment with  $T_A=25^\circ C$ . The value in any given application depends on the user's specific board design.

B: Repetitive rating, pulse width limited by junction temperature.

C: The current rating is based on the  $t \leq 10s$  junction to ambient thermal resistance rating.



# ACE4606TB

30V Complementary Enhancement Mode Field Effect Transistor

## Packaging Type

SOP-8

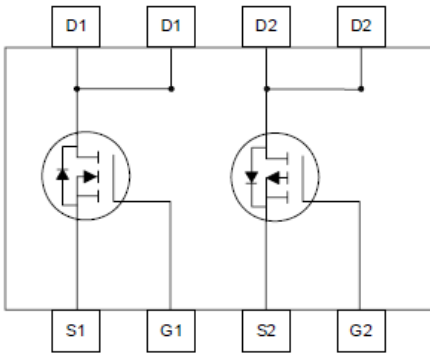

## Ordering information

ACE4606TB XX + H

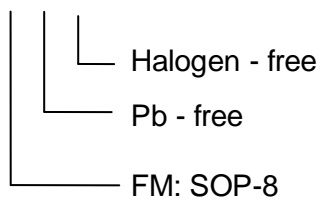



# ACE4606TB

## 30V Complementary Enhancement Mode Field Effect Transistor

### N-channel Electrical Characteristics $T_A=25\text{ }^\circ\text{C}$ unless otherwise noted

Parameter	Symbol	Conditions	Min.	Typ.	Max.	Unit
<b>Static</b>						
Drain-Source Breakdown Voltage	$V_{(BR)DSS}$	$V_{GS}=0V, I_D=250\mu A$	30			V
Zero Gate Voltage Drain Current	$I_{DSS}$	$V_{DS}=24V, V_{GS}=0V$			1	$\mu A$
Gate Threshold Voltage	$V_{GS(th)}$	$V_{DS}=V_{GS}, I_{DS}=250\mu A$	1	1.5	3	V
Gate Leakage Current	$I_{GSS}$	$V_{GS}=\pm 20V, V_{DS}=0V$			$\pm 100$	nA
Static Drain-Source On-Resistance	$R_{DS(on)}$	$V_{GS}=10V, I_D=5A$		23	26	m $\Omega$
		$V_{GS}=4.5V, I_D=5A$		34	45	
Forward Transconductance	$g_{FS}$	$V_{DS}=5V, I_D=7A$		14		S
Diode Forward Voltage	$V_{SD}$	$I_S=1A, V_{GS}=0V$			1.2	V
Maximum Body-Diode Continuous Current	$I_S$				7	A
<b>Switching</b>						
Total Gate Charge	$Q_g$	$V_{GS}=10V, V_{DS}=15V, I_D=7A$		11.5		nC
Gate-Source Charge	$Q_{gs}$			1.6		
Gate-Drain Charge	$Q_{gd}$			2.8		
Turn-on Delay Time	$t_{d(on)}$	$V_{GS}=10V, V_{DS}=10V, I_D=1A, R_{GS}=6\Omega$		11		ns
Turn-on Rise Time	$t_r$			16		
Turn-off Delay Time	$t_{d(off)}$			36		
Turn-off Fall Time	$t_f$			20		
<b>Dynamic</b>						
Input Capacitance	$C_{iss}$	$V_{GS}=0V, V_{DS}=15V, f=1MHz$		520		pF
Output Capacitance	$C_{oss}$			88		
Reverse Transfer Capacitance	$C_{rss}$			62		



# ACE4606TB

## 30V Complementary Enhancement Mode Field Effect Transistor

### P-channel Electrical Characteristics $T_A=25^\circ\text{C}$ unless otherwise noted

Parameter	Symbol	Conditions	Min.	Typ.	Max.	Unit
<b>Static</b>						
Drain-Source Breakdown Voltage	$V_{(BR)DSS}$	$V_{GS}=0V, I_D=-250\mu A$	-30			V
Zero Gate Voltage Drain Current	$I_{DSS}$	$V_{DS}=-24V, V_{GS}=0V$			-1	$\mu A$
Gate Threshold Voltage	$V_{GS(th)}$	$V_{DS}=V_{GS}, I_{DS}=-250\mu A$	-1	-1.5	-3	V
Gate Leakage Current	$I_{GSS}$	$V_{GS}=\pm 20V, V_{DS}=0V$			$\pm 100$	nA
Static Drain-Source On-Resistance	$R_{DS(ON)}$	$V_{GS}=-10V, I_D=-4A$		52	58	m $\Omega$
		$V_{GS}=-4.5V, I_D=-3A$		67	80	
Forward Transconductance	$g_{FS}$	$V_{DS}=-5V, I_D=-4A$		10		S
Diode Forward Voltage	$V_{SD}$	$I_S=-1A, V_{GS}=0V$			-1.1	V
Maximum Body-Diode Continuous Current	$I_S$				-4	A
<b>Switching</b>						
Total Gate Charge	$Q_g$	$V_{GS}=-10V, V_{DS}=-15V, I_D=-4A$		11.5		nC
Gate-Source Charge	$Q_{gs}$			2.5		
Gate-Drain Charge	$Q_{gd}$			2.2		
Turn-on Delay Time	$t_{d(on)}$	$V_{GS}=-10V, V_{DS}=-15V, I_D=1A, R_{GS}=6\Omega$		10		ns
Turn-on Rise Time	$t_r$			10		
Turn-off Delay Time	$t_{d(off)}$			18		
Turn-off Fall Time	$t_f$			15		
<b>Dynamic</b>						
Input Capacitance	$C_{iss}$	$V_{GS}=0V, V_{DS}=-15V, f=1MHz$		726		pF
Output Capacitance	$C_{oss}$			90		
Reverse Transfer Capacitance	$C_{rss}$			76		



### N-channel Typical Performance Characteristics

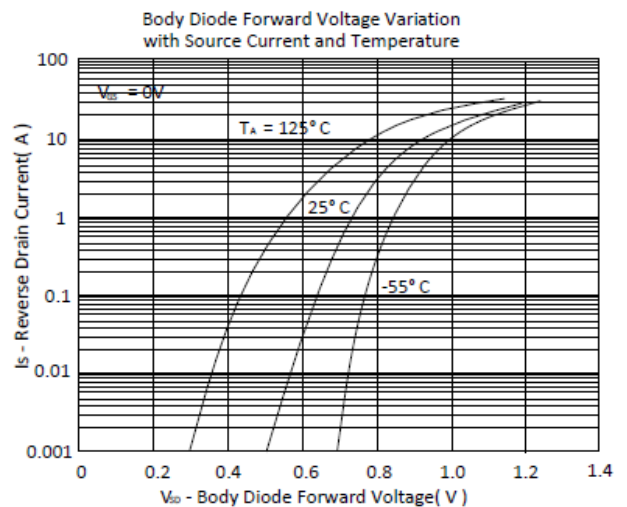
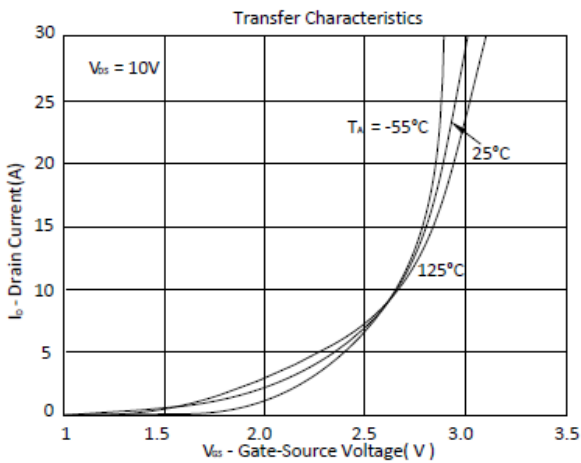
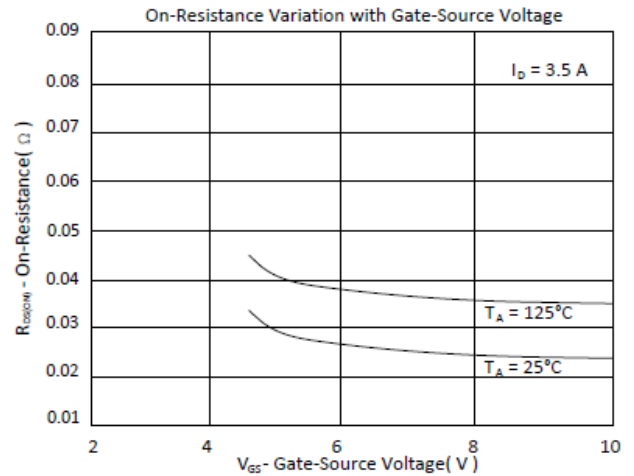
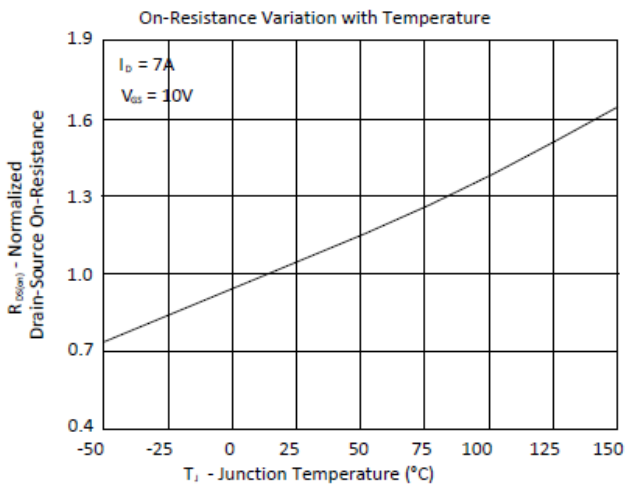
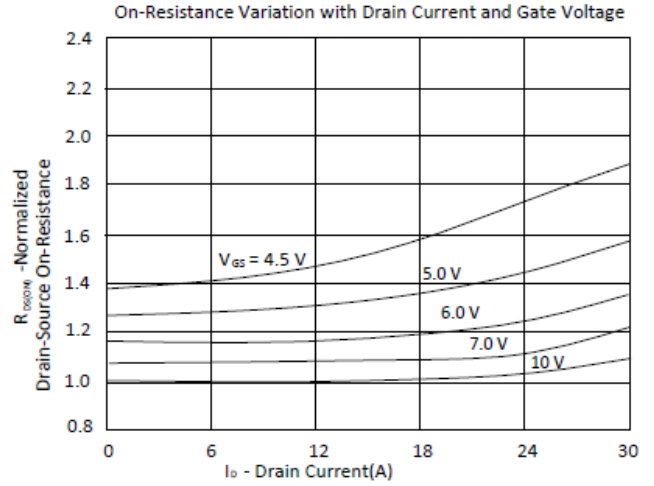
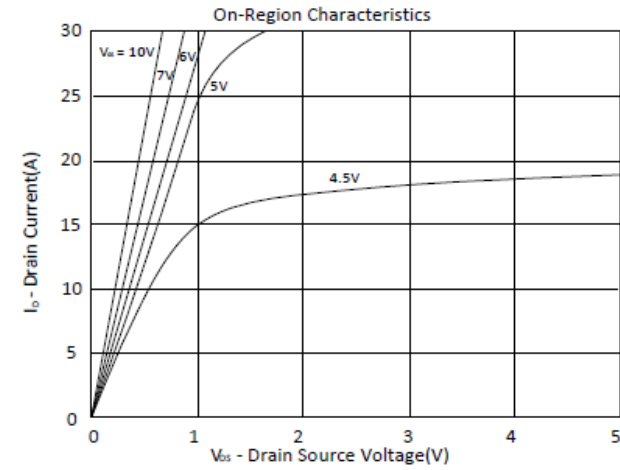



# ACE4606TB

## 30V Complementary Enhancement Mode Field Effect Transistor

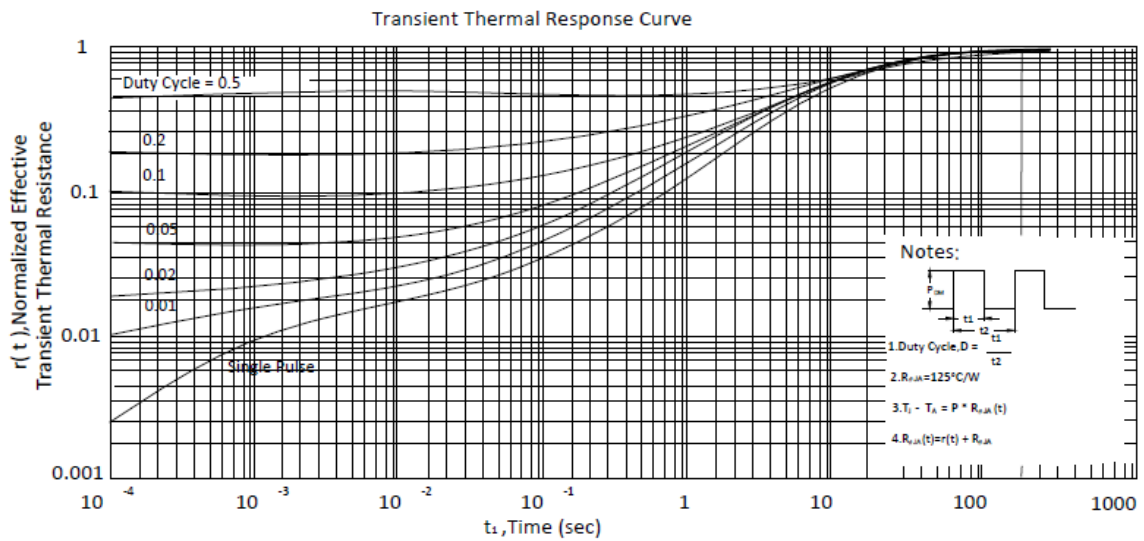
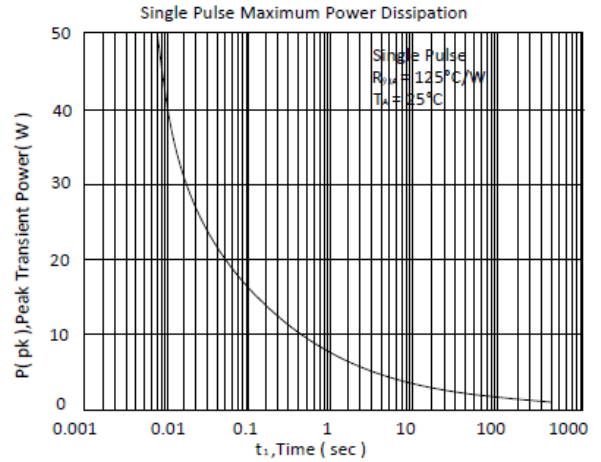
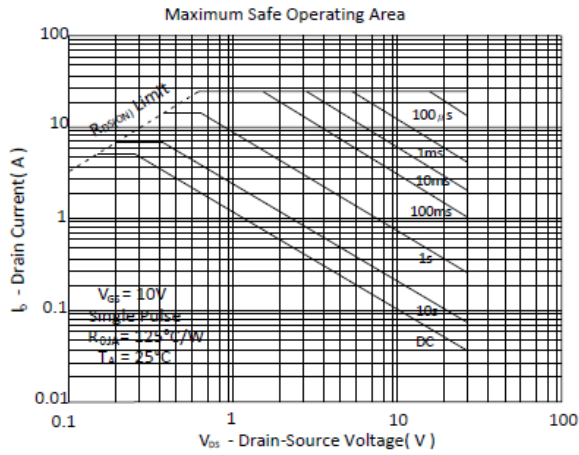
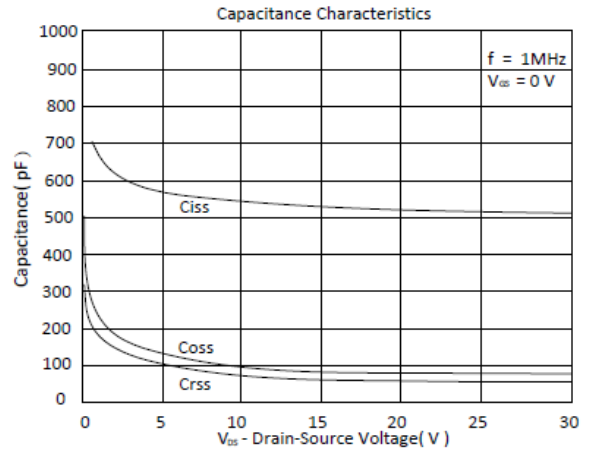
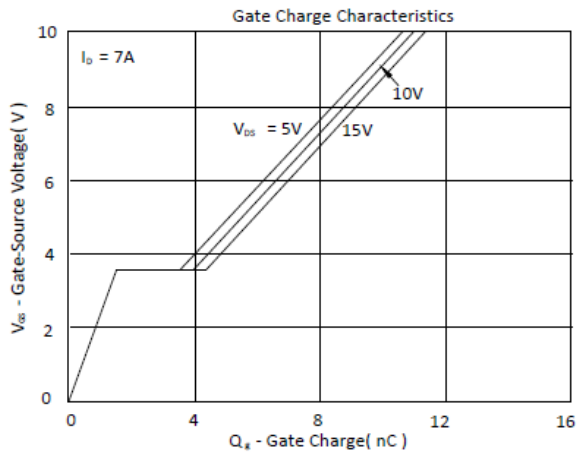



### P-channel Typical Performance Characteristics

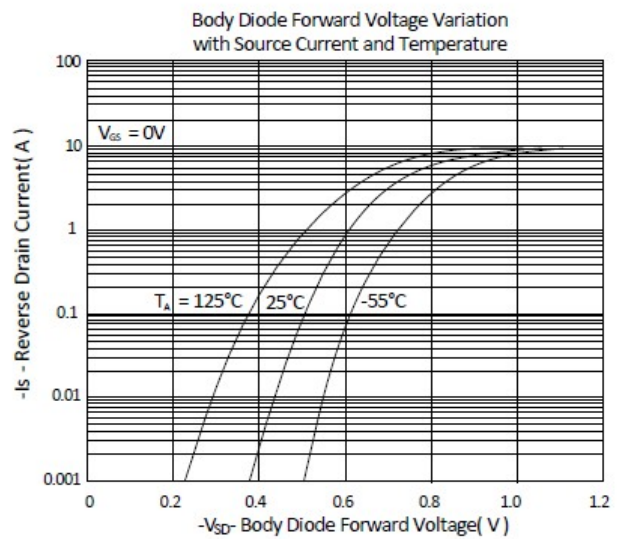
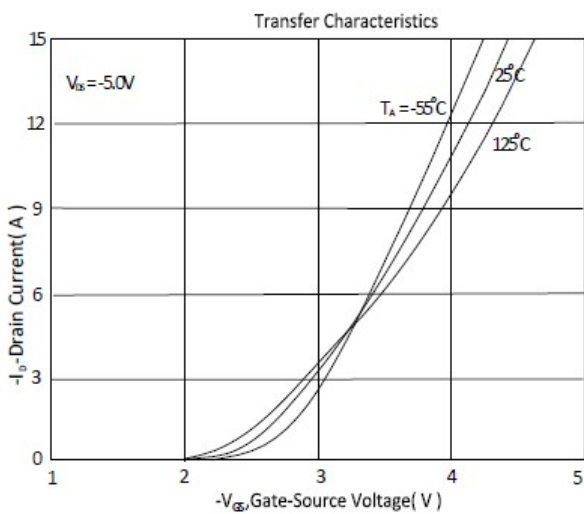
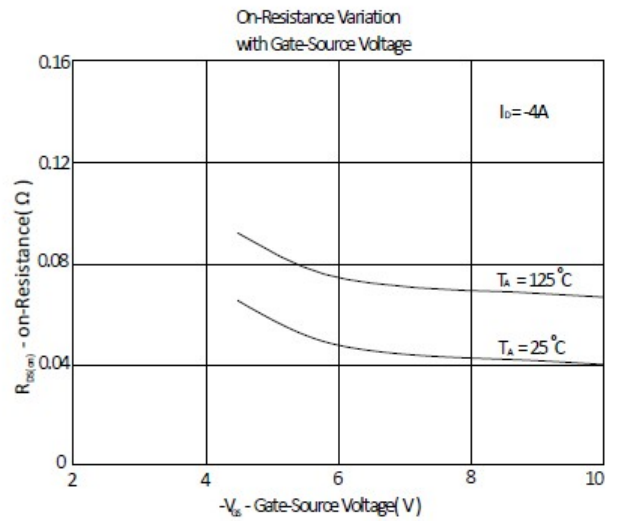
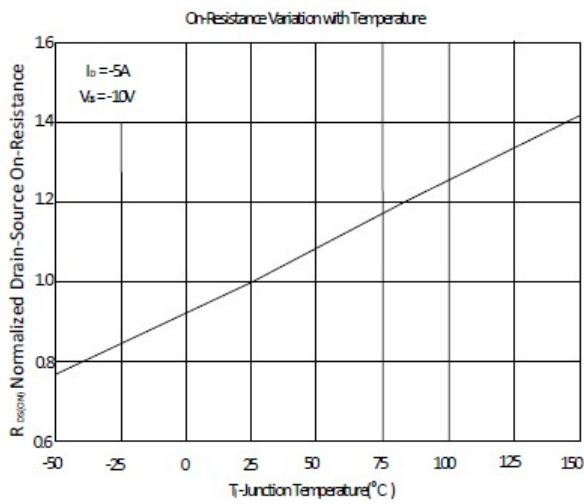
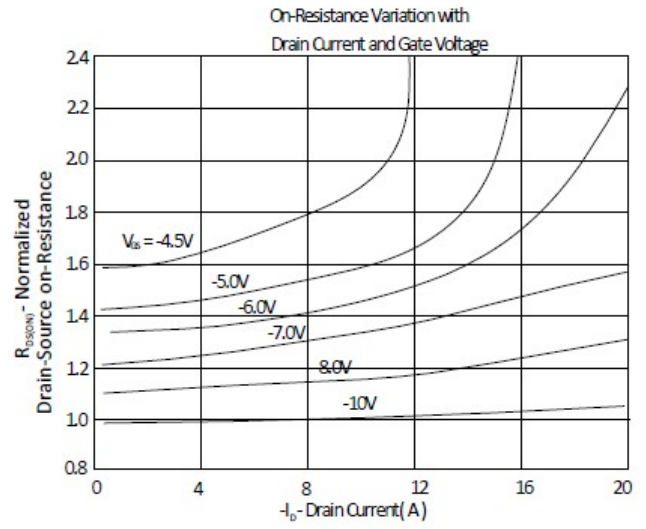
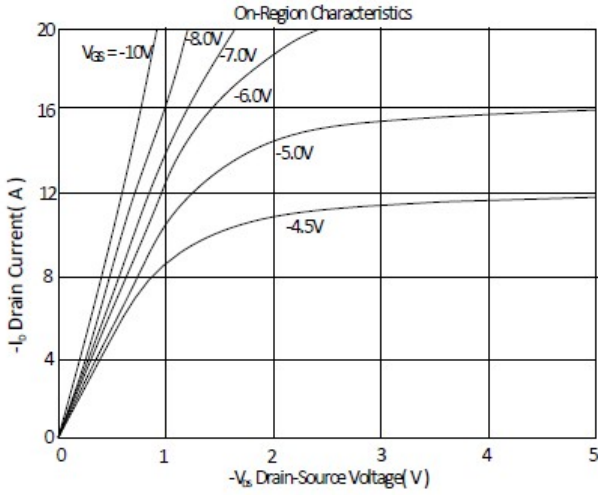



# ACE4606TB

## 30V Complementary Enhancement Mode Field Effect Transistor

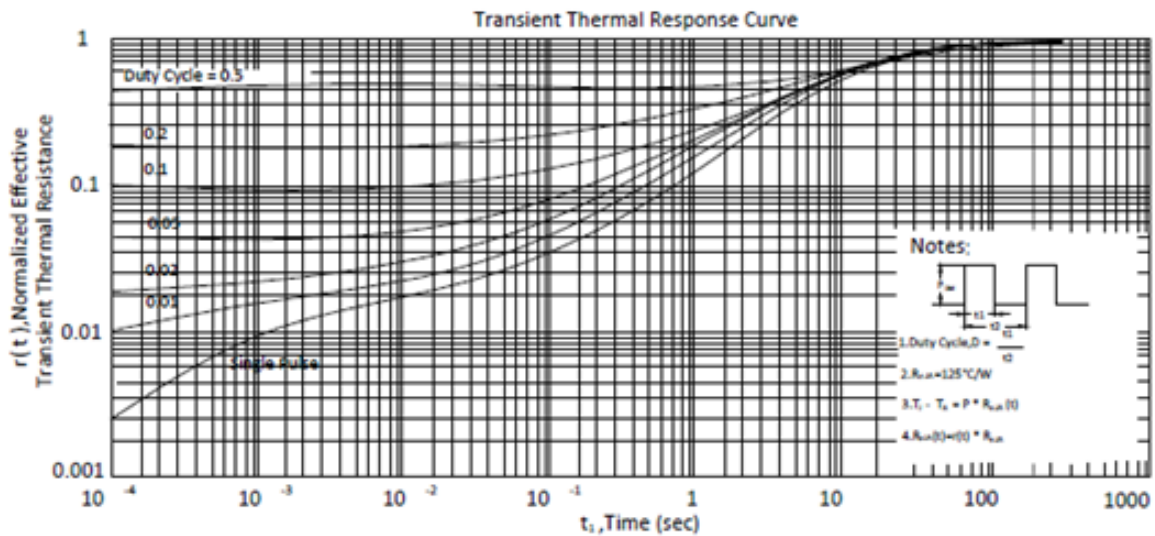
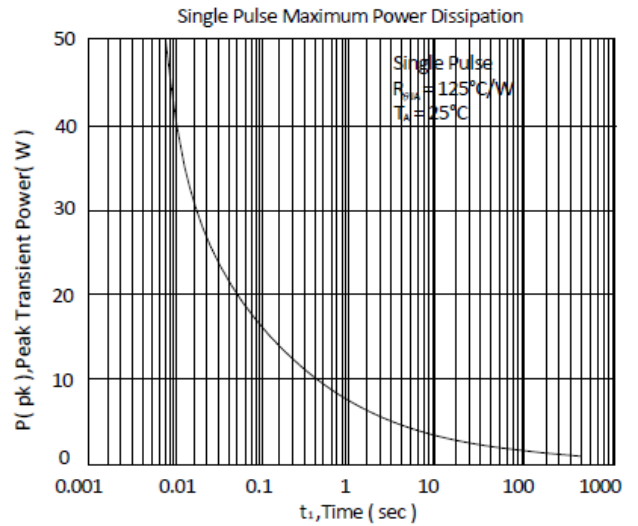
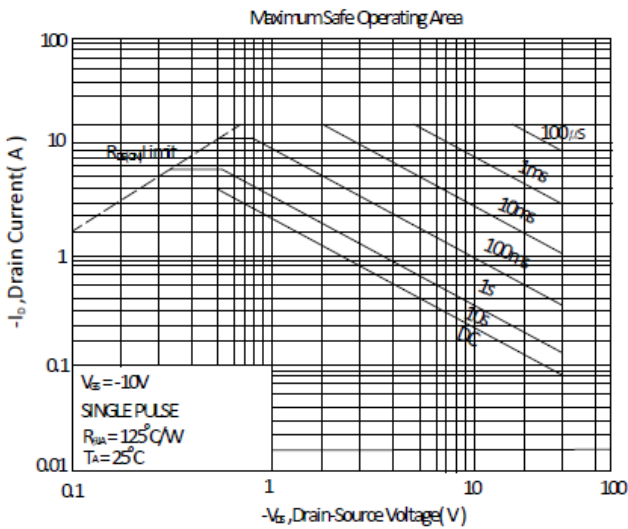
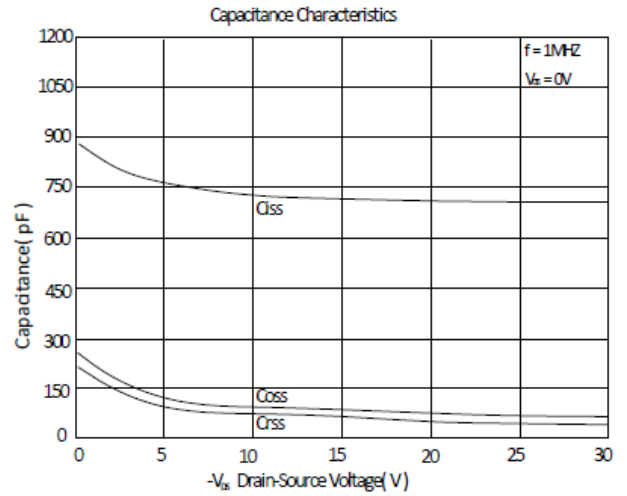
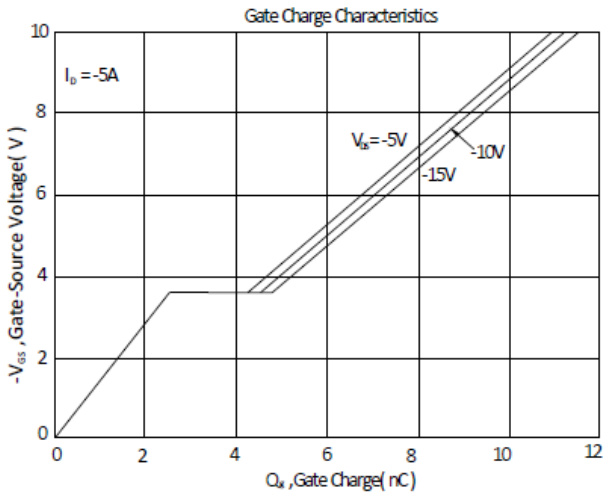





# ACE4606TB

## 30V Complementary Enhancement Mode Field Effect Transistor

### Packing Information

#### SOP-8

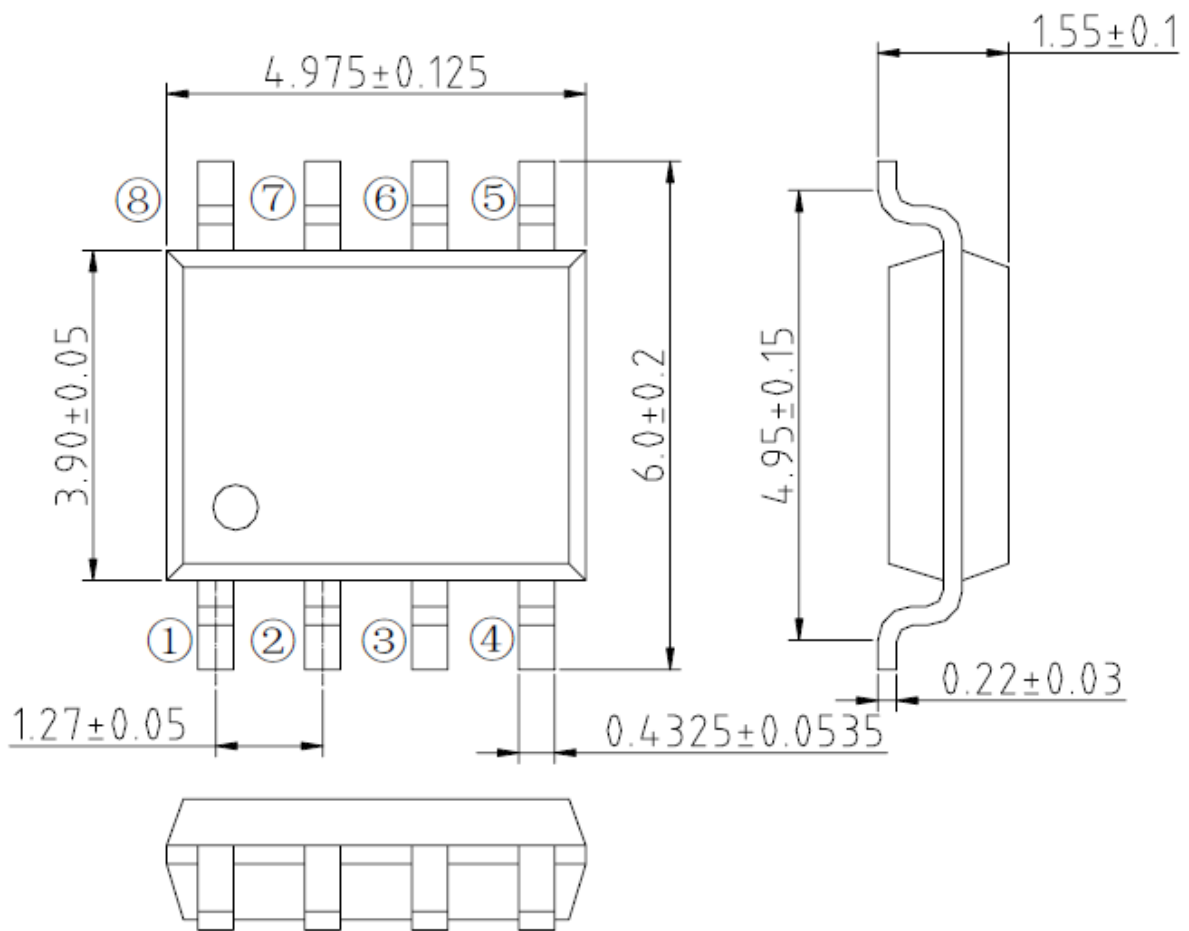

Units: mm



# ACE4606TB

## 30V Complementary Enhancement Mode Field Effect Transistor

### Notes

ACE does not assume any responsibility for use as critical components in life support devices or systems without the express written approval of the president and general counsel of ACE Electronics Co., LTD. As sued herein:

1. Life support devices or systems are devices or systems which, (a) are intended for surgical implant into the body, or (b) support or sustain life, and whose failure to perform when properly used in accordance with instructions for use provided in the labeling, can be reasonably expected to result in a significant injury to the user.
2. A critical component is any component of a life support device or system whose failure to perform can be reasonably expected to cause the failure of the life support device or system, or to affect its safety or effectiveness.